

Welcome to digital TV



A digital receiver lets you access digital channels that are broadcast in the UK. It uses a digital signal, received through your satellite dish and lets you watch it through your existing television.



For a one off payment, you can buy a freesat receiver, satellite dish and installation giving you over 80 channels covering the best of TV and more.

The big switchover

Over the next 4 years, the old analogue TV signal is gradually being switched off. Soon you'll only be able to watch television with a digital receiver.

www.digitaluk.co.uk also offers information about when the analogue signal is being switched off in your area.

Need extra information or help setting up?

You may find the information you are looking for on our website.

www.grundigdigital.co.uk

or on the freesat website.

www.freesat.co.uk

If you still need help or information you can phone our call centre on:

0871 230 4695

Calls are charged at 10p per minute when called from a BT landline. Call charges may vary if using other networks.

GRUNDIG

GUFSAT01HD
HD freesat receiver

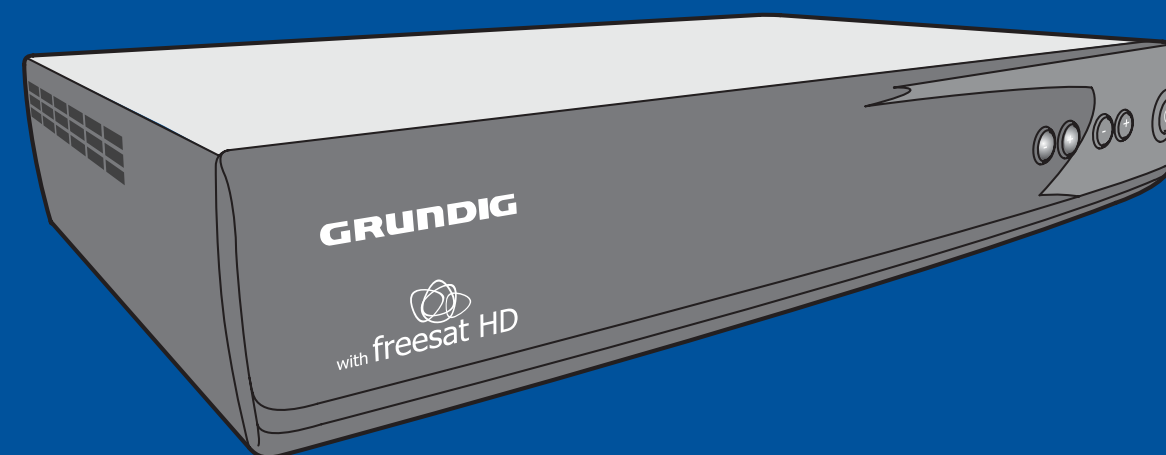

Start here

1

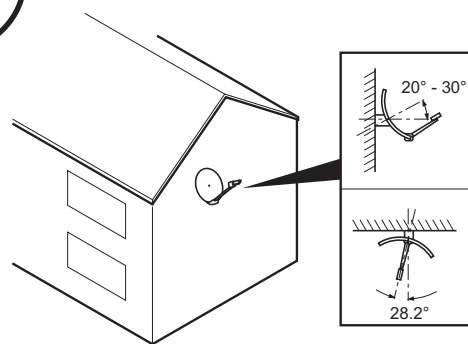

Install your satellite dish strictly following local council rules and regulations. The dish should face 28° East of South with an inclination of between 20° and 30°. (20° for North of the UK and 30° for the South of the UK).

2

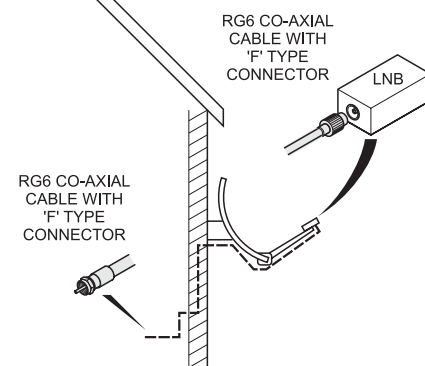

Connect a suitable RG6 Co-axial cable with a 'F' type connector to the LNB. Route the remaining end of the cable through the external wall and connect a 'F' type connector.

3

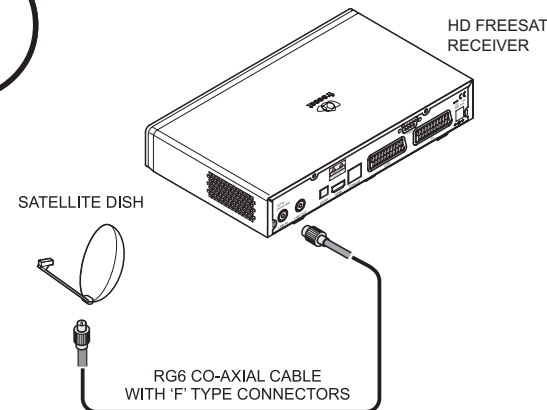

Connect the loose end of the RG6 Co-axial cable with the 'F' type connector fitted to the 'LNB IN' socket on the back of the freesat receiver.

4

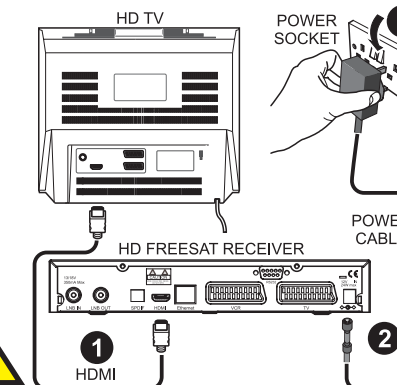
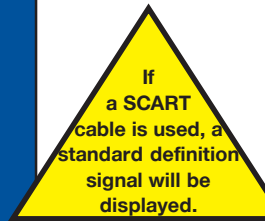

Connect a HDMI cable (not supplied) between your HD Ready TV and the freesat receiver. Connect the power adapter between the power socket and the freesat receiver. Turn the power socket On.

5

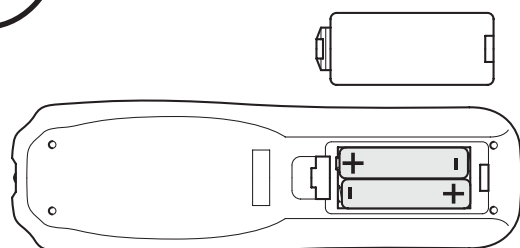

Remove the battery cover from the remote control and insert 2 x AAA batteries into the battery compartment.

6

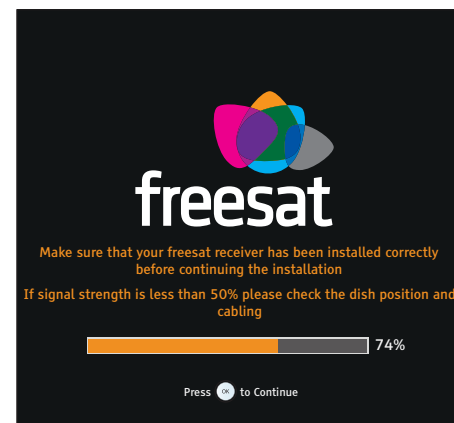

The first install screen will appear. If the signal strength is above 50% press the OK button to continue. If below 50% check the dish alignment and cable connections.

7



The Network ID and Transport ID are shown. The new system software will download and install automatically.

8

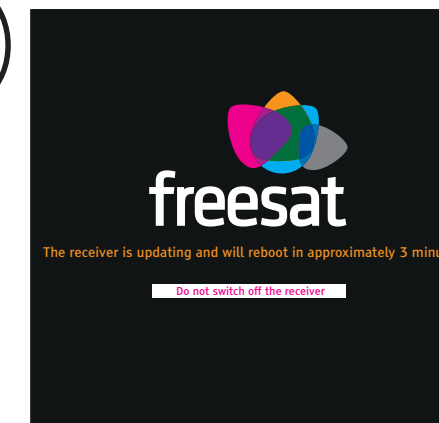

When the new system software has been downloaded, the above screen will appear. Do not switch off the receiver.

8b

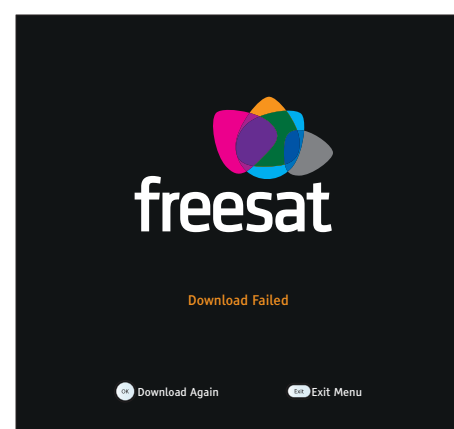

Should the software update fail, press the OK button to start again. If the problem persists, check all the connections between the dish and the receiver.

9

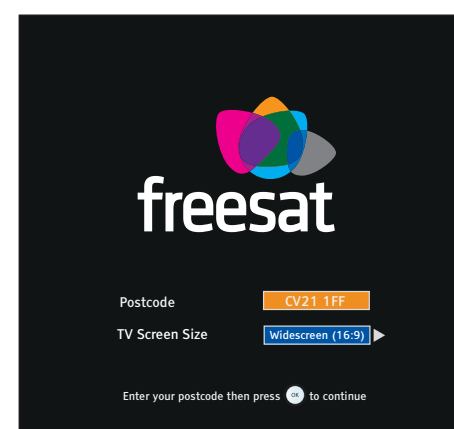

Use the number keys on the remote control to enter your postcode. The right arrow moves to the next space and the left arrow deletes the previous character. Press the OK button to continue.

10

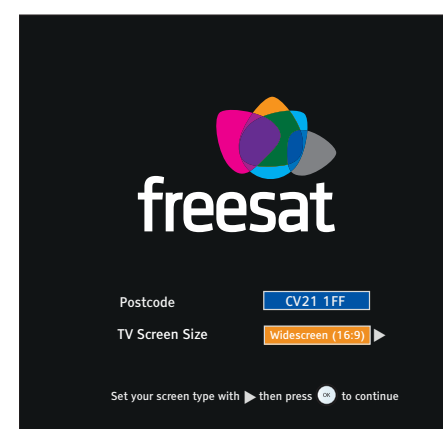

Use the right arrow to set your screen size/type. Press the OK button to continue. Your freesat receiver will now autotune.

You are now ready to watch tv. To learn more about your freesat receiver look in the main instruction manual.